



2015 | 



## Welcome to a new era in outboards.

Introducing a revolutionary concept in outboards—a choice. Now with Evinrude® E-TEC® engines, choose cutting-edge over commonplace. Choose more torque over more talk. Choose more time on the water over more time in the shop. Choose an outboard that perfectly matches your boat and your style of boating. Choose Evinrude E-TEC, the outboard that performs, and looks, like no other outboard in the world.

## The Power of Choice.

### TABLE OF CONTENTS

Introducing the Evinrude E-TEC G2™	4-5
Choose Unrivaled Performance	6-7
Choose Bold, Breakthrough Design	8-9
Choose Unmatched Lifetime Value	10-11
Choose the Cleanest Technology	12-13
Choose Your Evinrude Engine	14-15
Freshwater Fishing	16-19
Saltwater Fishing	20-23
Recreational	24-27
Government	28-29
Engine Specifications	30-35

Ocean Master 336 CC powered by twin Evinrude E-TEC G2 250 HP Engines

INTRODUCING THE ALL-NEW  
**Evinrude E-TEC G2.**



# The outboard of the future. Available today.

We invented the outboard. Now we've created the outboard of the future. Introducing the Evinrude E-TEC G2.

The new era of outboards is all about choice. When BRP engineers began designing the Evinrude E-TEC G2 outboard engine, they chose to start fresh, with a clean sheet of paper. They chose to dedicate months studying engine thermodynamics using advanced computational fluid dynamics software developed by

the University of Wisconsin. They chose to craft the entire engine around the moment of combustion and developed the first outboard engine block designed specifically for direct-injection technology. And with the freedom to develop any technology, they chose to stand by direct-injection two-stroke, because it's simply the best technology for the outboard engine application.

The results were startling, and now boaters truly do have a choice. Choose PurePower Combustion

to experience best-in-class torque, emissions and fuel efficiency. Choose an engine designed to fully integrate into your boat with Dual Axis Rigging, intelligent controls and gauges, and a fully customizable, bold, breakthrough look. Choose an engine that requires no dealer-scheduled maintenance for 5 years or 500 hours and is backed by a 5-year engine<sup>1</sup> and corrosion warranty, offering the most lifetime value of any outboard in the industry. Choose the cleanest combustion outboard on the planet. Choose an Evinrude E-TEC G2.

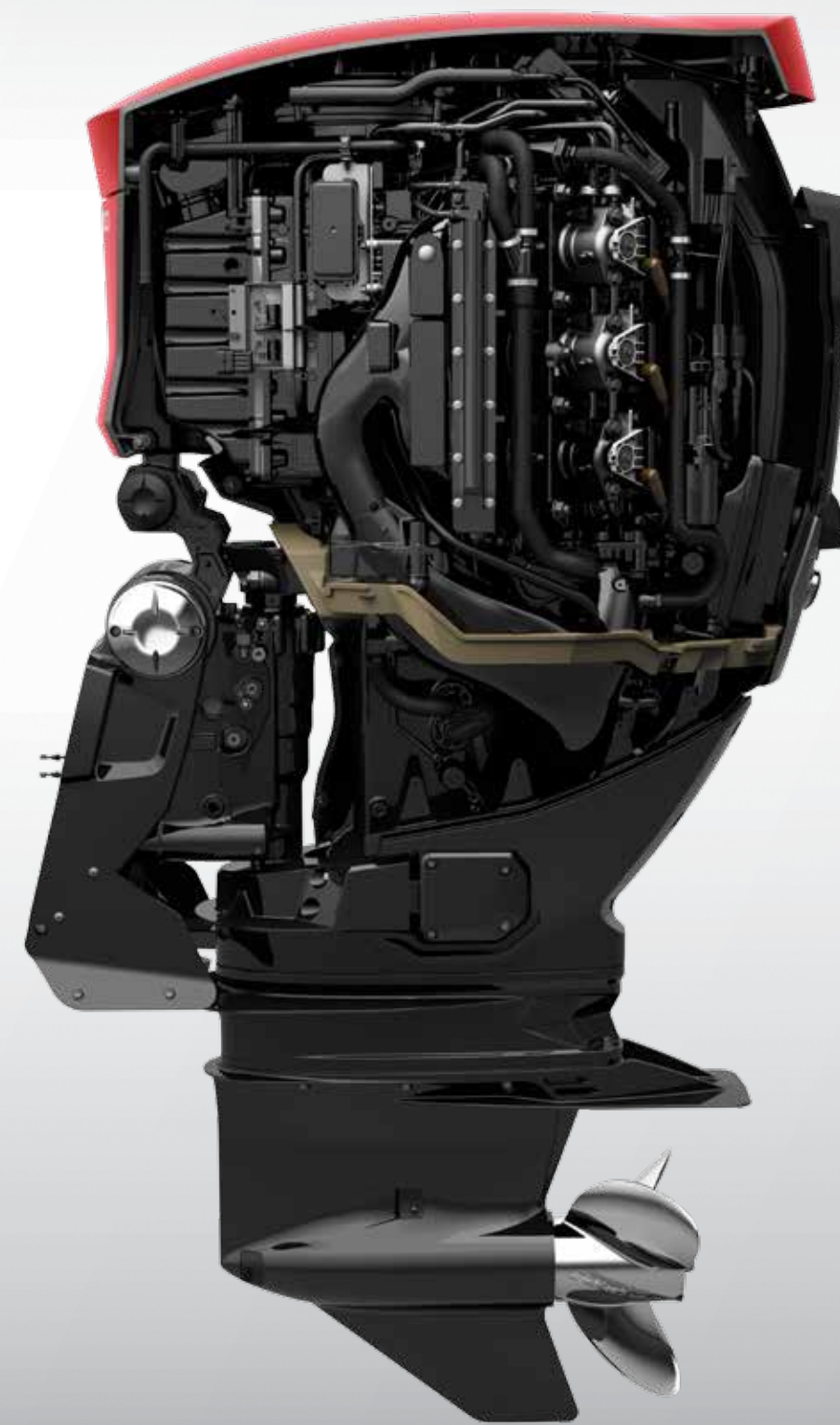

## Evinrude E-TEC G2 Exclusive Technologies



### PurePower Combustion

With the help of computer modeling, we looked inside an operating engine and created the most efficient piston/cylinder design in the industry, giving you better performance while also providing 15% more fuel efficiency versus competitive outboards.<sup>2</sup>



### Starboard-Starboard Engine Design

We've turned the outboard industry on its side. With the new Starboard-Starboard design, you get faster acceleration, better hole shots and more towing power as well as a more reliable engine.



### Dual Axis Rigging System

No more clutter in the back of your boat. The Dual Axis Rigging System routes engine cables through just one tube, giving you more useable space at the transom while creating less friction and premature wear.



### Fully Integrated Digital Control

Everything from the gauges to the throttle has been completely redesigned to give you better command of your engine, including i-Trim, the new intelligent trim system from Evinrude.



### SLX Gearcase

The all-new, sleek hydrodynamic SLX Gearcase reduces steering effort without sacrificing speed.



### Dynamic Power Steering

Dynamic Power Steering is integrated directly into the midsection. It's designed to adapt steering resistance to the boat application, delivering superior handling and more control in tight turns and big water.

## Design your own Evinrude E-TEC G2.

The Evinrude E-TEC G2 engine is the world's first outboard with customizable side, top and front panels, as well as accent colors. Now you have hundreds of different color combinations to choose from. Create an Evinrude E-TEC G2 to perfectly match your boat, or get an exclusive boat package with matching Evinrude E-TEC G2 colors.



### STEP 1 CHOOSE YOUR HORSEPOWER.



### STEP 2 CHOOSE FROM 5 SIDE PANEL COLORS.



### STEP 3 CHOOSE FROM 5 TOP AND FRONT PANEL COLORS.



### STEP 4 CHOOSE FROM 14 ACCENT COLORS.



DESIGN YOUR OWN EVINRUDE E-TEC G2 AT [ChooseYourETEC.com](http://ChooseYourETEC.com)

1. Available in select markets. (For North America, 3 years of BRP Limited Warranty plus 2 years of BRP Extended Service Terms B.E.S.T.)  
2. Based on BRP ICOMIA Fuel Efficiency Testing of BRP and competitive engines.

# Choose Unrivaled Performance.



## BEST-IN-CLASS TORQUE

With 20% more torque than competitive outboards, the PurePower Combustion process of the Evinrude E-TEC G2 delivers the most torque in its class.<sup>1</sup> By precisely mixing the perfect 14:1 air and fuel ratio, it also provides even faster acceleration, more stable RPMs and 15% more fuel efficiency.<sup>2</sup> In fact, every Evinrude E-TEC brings unbeatable low-end torque because of direct injection two-stroke technology.

## BUILT TO OUTPERFORM EVERY OTHER OUTBOARD IN THE WORLD.

Since its introduction in 2003, the direct-injected Evinrude E-TEC has been dominating the industry with best-in-class performance that's the envy of every boat owner without one. It uses the most precise amount of fuel required at every RPM, so not a single drop is wasted. And because every stroke is a power stroke, it jumps out of the hole every time you accelerate.

## SUPERIOR POWER-TO-WEIGHT RATIO

With significantly fewer moving parts than competitive four-strokes, Evinrude E-TEC engines boast the best overall power-to-weight ratio across many horsepower segments.<sup>3</sup> And the integrated features of the Evinrude E-TEC G2 eliminate the need for additional components, reducing the overall weight of your boat.



## REFINED HANDLING

The Evinrude E-TEC G2 features a new, fully integrated i-Trim, which automatically provides the most optimal trim, and Dynamic Power Steering for superior boat handling. The sleek and strong, hydrodynamic SLX Gearcase increases acceleration and reduces steering effort without sacrificing speed.

1. Based on BRP testing and advertised features of each competitive manufacturer at time of printing.  
2. Based on BRP ICOMIA Fuel Efficiency Testing of BRP and competitive engines.  
3. Based on BRP testing and advertised weights of each competitive manufacturer at time of printing.

Ranger Z521 Comanche - powered by an Evinrude E-TEC G2 250 H.O.

# Choose Bold, Breakthrough Design.



Blue Wave 2400 Pure Bay powered by an Evinrude E-TEC G2 300 HP

## HUNDREDS OF COLOR COMBINATIONS AVAILABLE

Choose from 5 side panel colors, 5 top and front panel colors, and 14 accent colors to design an engine to perfectly match your boat. Design your own Evinrude E-TEC G2 at [ChooseYourETEC.com](http://ChooseYourETEC.com).



## FULLY INTEGRATED DIGITAL CONTROL

Everything from the gauges to the throttle has been completely redesigned to give you better command of your Evinrude E-TEC G2 engine.

## THE FIRST OUTBOARD EVER DESIGNED TO PERFECTLY MATCH YOUR BOAT, INSIDE AND OUT.

Evinrude is committed to delivering the best engine for your style of boating, as evidenced by the Evinrude E-TEC Pontoon Series and H.O. Series. Now the new Evinrude E-TEC G2 offers the first and only customizable look, the cleanest rigging and fully integrated digital controls to perfectly match your boat, inside and out.

## INDUSTRY-FIRST CLEAN RIGGING

The proprietary Dual Axis Rigging System on the Evinrude E-TEC G2 routes each engine's cables through a single rigging tube, giving you more useable space at the transom while creating less friction and premature wear.





# Choose Unmatched Lifetime Value.

Manitou Legacy 25 SRS SHP powered by an Evinrude E-TEC 250 H.O.

## INDUSTRY-LEADING MAINTENANCE SCHEDULE

The Evinrude E-TEC redefined low maintenance with 3 years or 300 hours of no dealer-scheduled maintenance. The Evinrude E-TEC G2 once again sets the standard for ease of ownership by only requiring dealer-scheduled maintenance every 5 years or 500 hours.



## LESS OUT OF POCKET, MORE OUT ON THE WATER.

Evinrude E-TEC engines are built to give you the best value for your dollar with more time on the water and less time in the shop. It means lower ownership costs and less hassle. And with the new Evinrude E-TEC G2, you get the most lifetime value on the water.

### 5-YEAR ENGINE AND CORROSION WARRANTY

It's the industry's best coverage with a 5-year engine warranty<sup>1</sup> and 5-year non-declining corrosion warranty. No one else even comes close to that kind of peace of mind.



### BEST-IN-CLASS FUEL EFFICIENCY

With an Evinrude E-TEC G2, you'll spend a lot less at the pump because you'll burn 15% less fuel than the leading four-stroke. That means more money in your pocket and more time on the water.<sup>2</sup>



### WORRY-FREE OWNERSHIP

All Evinrude E-TEC engines feature Auto-Storage/Winterization, no break-in period and no oil changes, ever.

<sup>1</sup> Available in select markets. (For North America, 3 years of BRP Limited Warranty plus 2 years of BRP Extended Service Terms B.E.S.T.).  
<sup>2</sup> Based on BRP ICOMIA Fuel Efficiency Testing of BRP and competitive engines.



Choose the Cleanest\* Technology.

Robalo R222 powered by an Evinrude E-TEC G2 250 HP



**100% GLOBAL EMISSIONS COMPLIANT**

No matter where in the world your boating experience takes you, the Evinrude E-TEC G2 is welcome.

**THE CLEANEST\* OUTBOARD IN THE WORLD.**

You already find Evinrude E-TEC engines operating on some of the most heavily regulated bodies of water in the world. But that wasn't good enough. So we designed the Evinrude E-TEC G2 with the future in mind. From Day 1, we questioned the status quo, challenged convention and rethought every aspect of the outboard, from the inside out. \*The result takes our clean-burning, fuel-efficient legacy to the next level, making Evinrude E-TEC G2 the cleanest combustion outboard engine in the world.



**LOWEST EMISSION LEVELS**

Simply put, a more efficient engine is also a cleaner engine. In fact, the PurePower Combustion of an Evinrude E-TEC G2 is so clean burning that it's showing 75% fewer regulated emissions than competitive four-strokes, keeping waters clean for you and generations to come.



**BEST-IN-CLASS FUEL EFFICIENCY<sup>1</sup>**

The PurePower Combustion of an Evinrude E-TEC G2 efficiently mixes a perfect 14:1 air and fuel ratio, ensuring every drop is burned, not wasted.

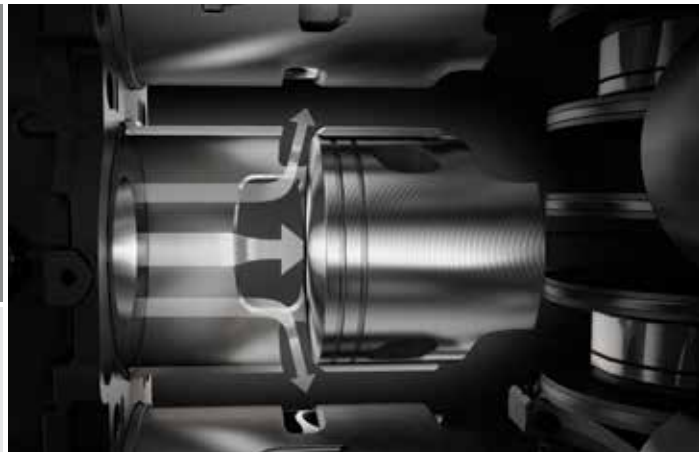

<sup>1</sup>. Based on BRP ICOMIA Fuel Efficiency Testing of BRP and competitive engines.



# Choose Your Evinrude.

We don't start designing outboards on paper. We start on the water—from the boater's perspective. We spend time with boaters, asking them what they need from an outboard and what they don't. Their answers guide us as we create outboards specifically designed for their particular boating experience. That's why boaters choose Evinrude E-TEC. We think that's why you will too.

**RANDY LINDEN,**  
E-NATION Member

“The simple, but high-tech, direct-injected two-stroke design of the E-TEC is what sets Evinrude apart.”



**FRESHWATER FISHING** — The torque to shoot out of the hole and onto your next spot. The reliability you need to get back to the dock at the end of the day.

16



**SALTWATER FISHING** — Overcome the challenges of big water with an outboard designed to resist corrosion and power over swells, all with low maintenance.

20



**RECREATIONAL** — Enjoy the water with a cleaner, quieter outboard that delivers ample low-end torque for towing.

24

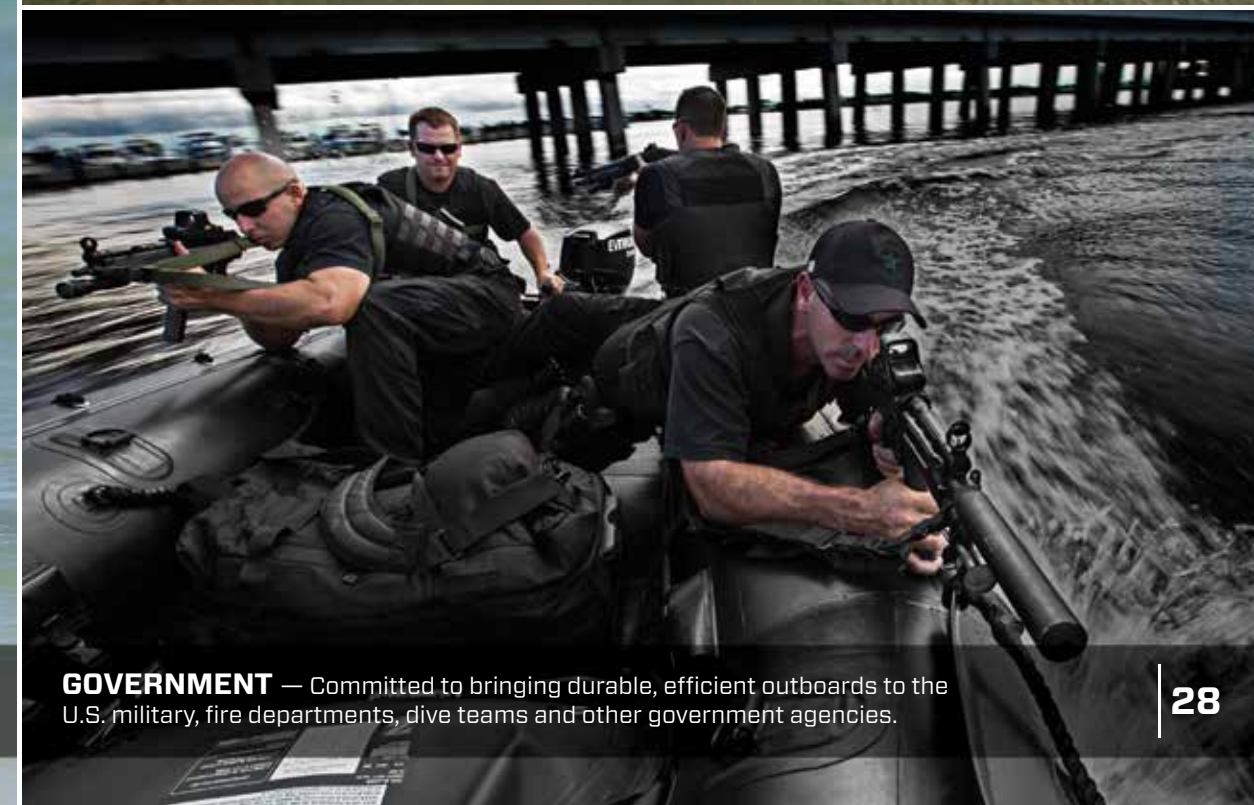

**GOVERNMENT** — Committed to bringing durable, efficient outboards to the U.S. military, fire departments, dive teams and other government agencies.

28

Design an Evinrude E-TEC G2 to perfectly match your boat.  
[ChooseYourETEC.com](http://ChooseYourETEC.com)



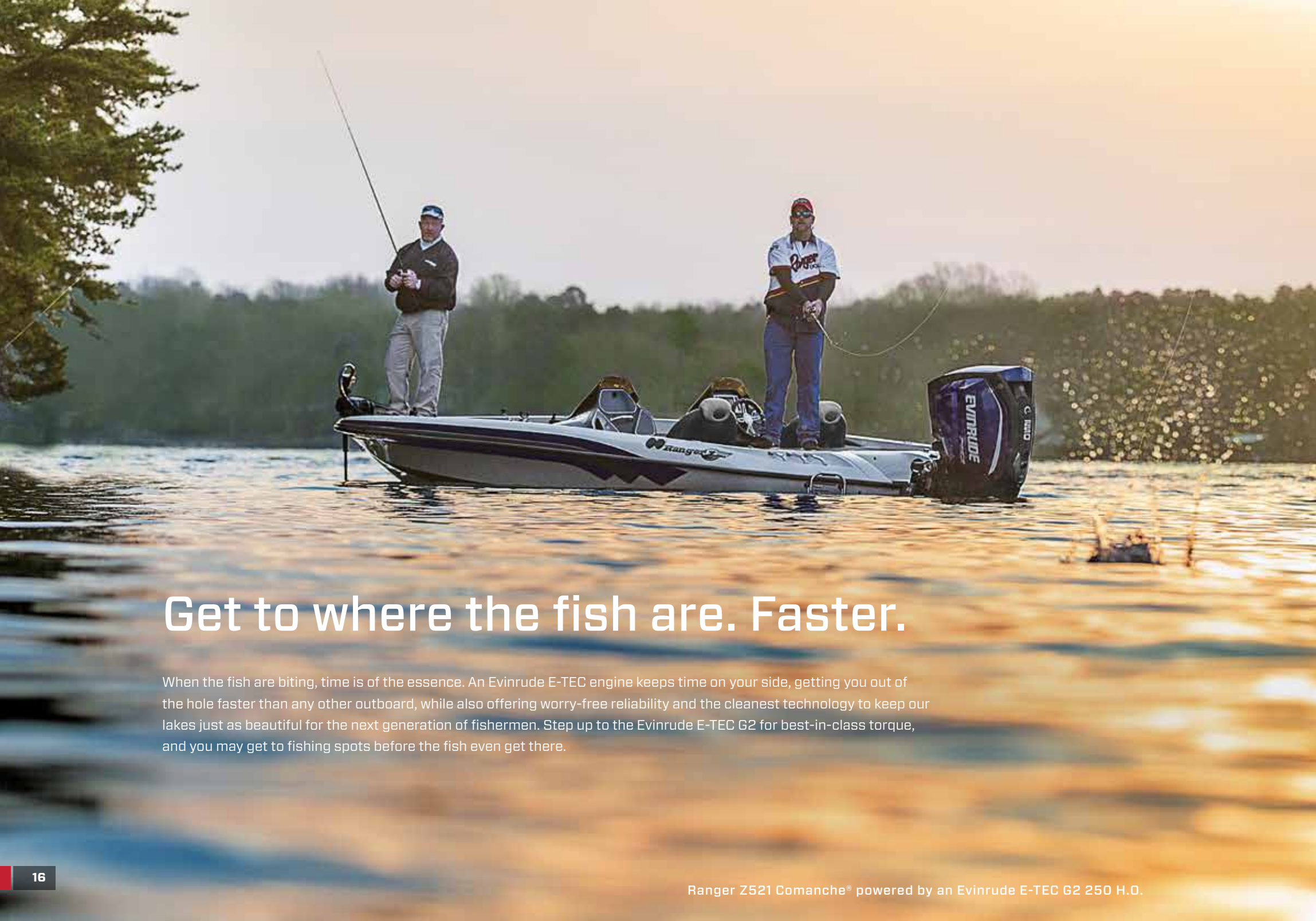

# Get to where the fish are. Faster.

When the fish are biting, time is of the essence. An Evinrude E-TEC engine keeps time on your side, getting you out of the hole faster than any other outboard, while also offering worry-free reliability and the cleanest technology to keep our lakes just as beautiful for the next generation of fishermen. Step up to the Evinrude E-TEC G2 for best-in-class torque, and you may get to fishing spots before the fish even get there.

## FRESHWATER FISHING



### EVINRUDE E-TEC G2 250 H.O.

- Tuned for extra power and speed
- SLX Gearcase for faster time to plane and optimal reliability
- Dual Axis Rigging for more useable space and less clutter



### EVINRUDE E-TEC 15 H.O. KICKER

- Lightweight, yet extremely tough trolling motor
- Plenty of electrical output
- Superior control from lowest trolling speeds in its class



### RX4 SERIES PROP

A no-compromises four-blade prop designed for the Evinrude E-TEC G2, it's optimized for traction and rough water performance with industry-leading speed, acceleration and fuel economy. It delivers superior bow lift on larger boats and doesn't slip in turns.

### BEST-IN-CLASS TORQUE

The natural two-stroke advantage paired with direct injection and the combustion system of an Evinrude E-TEC G2 means 20% more torque than a competitive outboard. Hole shots? More like slingshots.

- Evinrude E-TEC G2 250 H.O.
- Yamaha V MAX SHO® 250
- Mercury OptiMax Pro XS 250HP

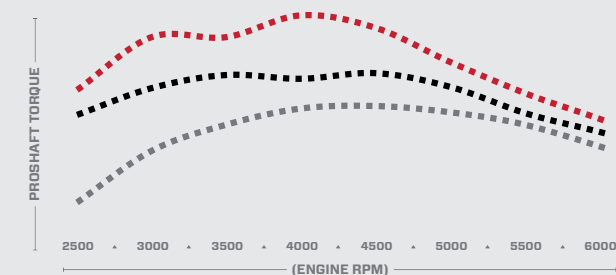

### ALL-NEW I-TRIM SYSTEM

Another exclusive Evinrude E-TEC G2 feature is the i-Trim system. i-Trim automatically trims the boat out for any given speed and can make even the most novice of drivers trim their boat like a pro.

RANDALL THARP, 2013 Forrest Wood Cup Champion

“One thing I never have to worry about is my engine.”

 Randall is a member of E-NATION, and you should be too. Sign up today at [EvinrudeNation.com](http://EvinrudeNation.com)

### LOWEST REGULATED EMISSIONS

It's the cleanest combustion outboard ever made, with the lowest regulated emissions of any outboard in its class,<sup>1</sup> which means a better environment for you and all the fish out there.

1. Based on BRP testing and advertised features of each competitive manufacturer at time of printing.



DAVID WALKER, Bassmaster Elite Series Angler

“Evinrude performance is undeniable. I run the fastest and most responsive outboard, period.”



**EVINRUDE E-TEC 60 HP**

- Smooth running with exceptional durability
- Mid-range horsepower packs a big punch
- Fast-Rise Inductive Ignition for longer spark life



**EVINRUDE 9.8 HP PORTABLE**

- Compact, simple convenience
- Flow-through prop for quiet operation
- CD Ignition for easier, faster starting



**LESS WEIGHT, MORE POWER**

An Evinrude E-TEC engine is as much as 100+ pounds lighter than competitive engines.<sup>1</sup> You're on plane faster, with less bow rise, so you can see the open water in front of you.



**AUTO-STORAGE / WINTERIZATION**

Do it yourself in less than four minutes—any time your boat will sit. Warm day in November or December? Go fishing and re-fog. No need for “done until spring” winterizing.



David Walker is a member of E-NATION, and you should be too. Sign up today at [EvinrudeNation.com](http://EvinrudeNation.com)



**TILLER KIT WITH TOUCH TROLL**

All the features and controls right at your fingertips. Fully adjustable to maximize comfort at your various running speeds.

**ICON TOUCH DISPLAY**

Rugged, functional and very easy to use, it provides all the information you need while out on the water.

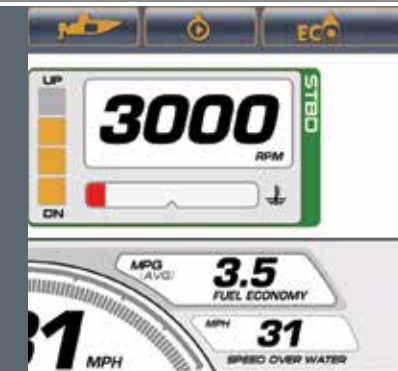

**PREFERRED FRESHWATER FISHING BOAT PARTNERS**

- |   |  |   |  |
|---|--|---|--|
| Alumacraft — <a href="http://Alumacraft.com">Alumacraft.com</a>                 | Mirrocraft — <a href="http://MirroCraft.com">MirroCraft.com</a>            | Smokercraft — <a href="http://SmokerCraft.com">SmokerCraft.com</a>          | Triumph Boats — <a href="http://TriumphBoats.com">TriumphBoats.com</a>       |
| Bass Cat — <a href="http://BassCat.com">BassCat.com</a>                         | Ranger — <a href="http://RangerBoats.com">RangerBoats.com</a>              | Starcraft — <a href="http://StarcraftMarine.com">StarcraftMarine.com</a>    | War Eagle — <a href="http://WarEagleBoats.com">WarEagleBoats.com</a>         |
| Excel Boats — <a href="http://ExcelBoats.net">ExcelBoats.net</a>                | Phoenix — <a href="http://PhoenixBassBoats.com">PhoenixBassBoats.com</a>   | Starweld — <a href="http://StarcraftStarweld.com">StarcraftStarweld.com</a> | Warrior Boats — <a href="http://WarriorBoatsINC.com">WarriorBoatsINC.com</a> |
| KingFisher Boats — <a href="http://KingFisherBoats.com">KingFisherBoats.com</a> | Polar Kraft — <a href="http://PolarKraftBoats.com">PolarKraftBoats.com</a> | Stratos — <a href="http://StratosBoats.com">StratosBoats.com</a>            | Weldcraft — <a href="http://WeldcraftMarine.com">WeldcraftMarine.com</a>     |
| Larson — <a href="http://LarsonBoats.com">LarsonBoats.com</a>                   | Sea Ark — <a href="http://SeaArkBoats.net">SeaArkBoats.net</a>             | Triton Boats — <a href="http://TritonBoats.com">TritonBoats.com</a>         | Wooldridge — <a href="http://WooldridgeBoats.com">WooldridgeBoats.com</a>    |

Smokercraft Ultima 172 powered by an Evinrude E-TEC 90 H.O.

<sup>1</sup> Based on published competitive weights at time of print.

# Nothing comes easy on the open seas. Until now.

The ocean is not to be messed with, so we build Evinrude E-TEC engines for the toughest seas, the saltiest waters, the choppiest channels and the biggest swells. When you're miles from shore and a storm is approaching, you'll have the confidence that the most reliable outboard on water has got your back. And the new Evinrude E-TEC G2 takes that reliability even further, with the most comprehensive warranty in the industry.



Ocean Master 336 CC powered by twin Evinrude E-TEC G2 250 HP engines

## SALTWATER FISHING



### EVINRUDE E-TEC G2 300 HP

- More torque and top-end speed to get on plane faster and handle heavy seas
- Use of stainless steel and coating of titanium oxide enable industry-leading 5-year corrosion warranty



### EVINRUDE E-TEC G2 250 HP

- Best power-to-weight for better fuel efficiency and control<sup>1</sup>
- Redesigned SLX Gearcase makes it the industry's most durable engine
- No dealer-scheduled maintenance for 5 years or 500 hours

## CORROSION RESISTANCE

Stainless steel components, a titanium oxide coating and an electro-deposition paint process resist corrosion. The Evinrude E-TEC G2 adds to that with a 5-year corrosion warranty.

PDXDAVE, E-NATION Member

“Reliability and simplicity. I love my Evinrude E-TEC.”



PDXDave is a member of E-NATION, and you should be too. **Sign up today at [EvinrudeNation.com](http://EvinrudeNation.com)**



## EVINRUDE I-DOCK

Whether you own a power catamaran, a high performance cruiser or have an offshore center console, the i-Dock takes the stress out of docking and launching a dual-engine boat.



## 5-YEAR ENGINE WARRANTY

The Evinrude E-TEC G2 is so durable, we're backing it with an industry-leading 5-year warranty.<sup>2</sup>

1. Based on BRP ICOMIA Fuel Efficiency Testing of BRP and competitive engines and published competitive weights at time of printing.  
2. Available in select markets. (For North America, 3 years of BRP Limited Warranty plus 2 years of BRP Extended Service Terms B.E.S.T.)



C.A. RICHARDSON, Flats Class TV Host

“Whether I’m guiding someone on their first tarpon fishing trip or competing in a professional tournament, the only engine I’d want on my transom is my Evinrude E-TEC.”

Beaver Tail 18 BT3 powered by an Evinrude E-TEC 90 HP



**EVINRUDE E-TEC 135 H.O.**

- 3 years/300 hours with no dealer-scheduled maintenance
- Lightweight design for best-in-class power-to-weight
- Powerful two-stroke, direct-injection performance



**EVINRUDE E-TEC 90 H.O.**

- Smooth running with exceptional durability
- Mid-range horsepower packs a big punch
- Fast-Rise Inductive Ignition provides longer spark life



**RAKER H.O. PROP**

By fully utilizing power and torque, this three-blade prop is the industry benchmark for high-speed operation. Now, the Raker H.O. boasts Variable Vent Ports to maximize hole-shot acceleration.



C.A. Richardson is a member of E-NATION, and you should be too. Sign up today at [EvinrudeNation.com](http://EvinrudeNation.com)



**MORE POWER, LESS FUEL**

The two-stroke, direct-injected power advantage means you’re on plane faster, you have more power to handle heavy seas without the need to add more throttle and you’re saving on fuel costs all the way through.



**SLE GEARCASE**

The nose cone water pickups of the SLE (Straight Leading Edge) provide maximum water intake in all conditions. Along with the weed-shedding shape, it results in a cooler-running engine for ultimate durability and reliability.



**FAIL-SAFE PROTECTION**

In the event of overheating or a no-oil situation, all Evinrude E-TEC outboards automatically reduce power to give you a five-hour window to get back.



**PREFERRED SALTWATER FISHING BOAT PARTNERS**

- Aeon — [AeonMarine.com](http://AeonMarine.com)
- Beavertail — [ExploreBeavertail.com](http://ExploreBeavertail.com)
- Andros — [AndrosBoats.com](http://AndrosBoats.com)
- Bay Craft — [BayCraftINC.com](http://BayCraftINC.com)
- Blue Wave — [BlueWaveBoats.com](http://BlueWaveBoats.com)
- Bluewater — [BluewaterBoats.com](http://BluewaterBoats.com)

- Cape Horn — [CapeHornBoats.com](http://CapeHornBoats.com)
- Carolina Skiff — [CarolinaSkiff.com](http://CarolinaSkiff.com)
- Contender — [ContenderOffShore.com](http://ContenderOffShore.com)
- Dusky — [Dusky.com](http://Dusky.com)
- East Cape Skiffs — [EastCapeSkiffs.com](http://EastCapeSkiffs.com)
- Key West — [KeyWestBoats.com](http://KeyWestBoats.com)

- KingFisher Boats — [KingFisherBoats.com](http://KingFisherBoats.com)
- Ocean Master — [OceanMasterBoats.com](http://OceanMasterBoats.com)
- Ranger — [RangerBoats.com](http://RangerBoats.com)
- Sailfish Boats — [SailfishBoats.com](http://SailfishBoats.com)
- Scout Boats — [ScoutBoats.com](http://ScoutBoats.com)
- Shallow Sport — [ShallowSportBoats.com](http://ShallowSportBoats.com)

- Shoalwater Boats — [ShoalwaterBoats.com](http://ShoalwaterBoats.com)
- Striper — [StriperBoats.com](http://StriperBoats.com)
- Wellcraft — [Wellcraft.com](http://Wellcraft.com)
- Wooldridge — [WooldridgeBoats.com](http://WooldridgeBoats.com)

# Outboards specifically designed for fun.

Nothing should come between you and a good time on the water. Especially your outboard. So we developed quieter, cleaner, more reliable Evinrude E-TEC engines for recreational boating. It's the type of outboard that you and your guests won't even notice. Until you hit the throttle.



Tahoe Vision Entertainer 27' powered by an Evinrude E-TEC G2

## RECREATIONAL BOATING



### EVINRUDE E-TEC G2 200 H.O.

- World's cleanest combustion outboard meets all global emissions standards
- 5 years/500 hours with no dealer-scheduled maintenance<sup>1</sup>
- Engine Management Module for optimal fuel injection and ignition



### AUTO-STORAGE / WINTERIZATION

Why put your pontoon away in September? You can fog it and re-fog it anytime. It's automatic and takes just four minutes. Virtually eliminates traditional winterizing, saving you money and hassle. Nice day in November? Take the boat out.



### ICON 3.5 CS

Get the information you need without any fuss. The ICON 3.5CS is a simple, intuitive display unit that gives you everything your engine can offer at the touch of a finger.

## INDUSTRY-LEADING MAINTENANCE SCHEDULE

The ease of owning an Evinrude E-TEC is unrivaled. With every Evinrude E-TEC engine, you get 3 years or 300 hours with no dealer-scheduled maintenance. With the Evinrude E-TEC G2, we've upped the ante, giving you 5 years or 500 hours with no dealer-scheduled maintenance<sup>1</sup>.

1. Available in select markets. (For North America, 3 years of BRP Limited Warranty plus 2 years of BRP Extended Service Terms B.E.S.T.)



## HIGH-OUTPUT BELTLESS ALTERNATOR

Industry-leading 50 net amps of battery-charging output on Evinrude E-TEC 115-HP models and up. Maximum charging for all your accessories—right down to the blender and stereo.

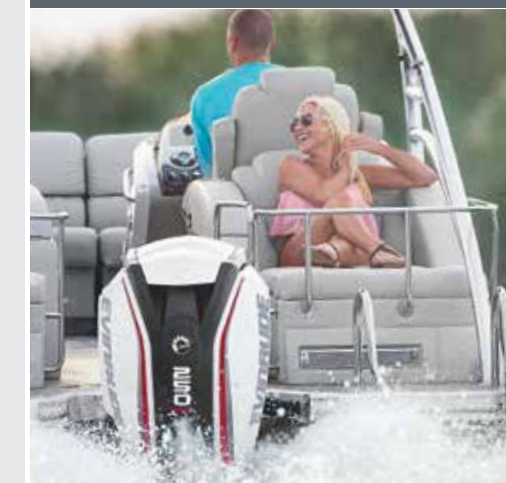

With Evinrude E-TEC, record-breaking performance is the standard.

What do you get when you combine 60 Team Evinrude ski team members and the power of 900 horses? A world-record water-ski pull.



Check out The Big Pull at [EvinrudeNation.com](http://EvinrudeNation.com).



E-NATION MEMBER "AA24BOAT"

"With Evinrude E-TEC, I can actually carry on a conversation without yelling to be heard over the engine noise."



Glastron GTS 200 powered by an Evinrude E-TEC 150 HP

## EVINRUDE E-TEC PONTOON SERIES

The Evinrude E-TEC Pontoon Series is specifically designed to reduce vibration for a smoother, more comfortable ride, while also providing quicker acceleration, improved throttle response and more stopping power. And you still get Evinrude E-TEC standard features such as direct injection and stratified combustion for ultra-low emissions and extremely high fuel efficiency. It's the only outboard specifically made for your pontoon.

Learn more at [EvinrudePontoonSeries.com](http://EvinrudePontoonSeries.com).



150 HP | 115 HP | 90 HP | 65 HP

- Softened rubber motor mounts significantly reduce vibration at any speed
- Remote Oil Tank extends fill-up interval up to 100 hours
- Unique gear ratio and large-displacement cylinder blocks for improved throttle response, thrust and stopping power



### VIPER PROP

The Viper prop features longer swept blades and a larger diameter for better acceleration and grip on the water. Perfect for pontoons, runabouts, cruisers and deck boats.



### PREFERRED RECREATIONAL BOAT PARTNERS

Apex Marine — [ApexMarineInc.com](http://ApexMarineInc.com)  
Avalon — [AvalonPontoons.com](http://AvalonPontoons.com)  
Bennington — [BenningtonMarine.com](http://BenningtonMarine.com)  
Campion — [CampionBoats.com](http://CampionBoats.com)  
Craig Cat — [CraigCat.com](http://CraigCat.com)  
Crest — [CrestPontoonBoats.com](http://CrestPontoonBoats.com)  
Crownline — [Crownline.com](http://Crownline.com)  
Ebbtide Boats — [EbbtideBoats.com](http://EbbtideBoats.com)

Encore Bentley Pontoons — [EncoreBoatBuilders.com](http://EncoreBoatBuilders.com)  
Four Winns — [FourWinns.com](http://FourWinns.com)  
Forest River — [ForestRiverInc.com](http://ForestRiverInc.com)  
Godfrey — [GodfreyPontoonBoats.com](http://GodfreyPontoonBoats.com)  
Glastron — [Glastron.com](http://Glastron.com)  
Hurricane — [HurricaneBoats.com](http://HurricaneBoats.com)  
JC Pontoon — [JCPontoon.com](http://JCPontoon.com)

Manitou — [ManitouPontoonBoats.com](http://ManitouPontoonBoats.com)  
Montego Bay Pontoons — [MontegoBayPontoons.com](http://MontegoBayPontoons.com)  
Misty Harbor — [MistyHarborBoats.com](http://MistyHarborBoats.com)  
Palm Beach — [PalmBeachMarine.com](http://PalmBeachMarine.com)  
Parti Kraft — [PartiKraftBoats.com](http://PartiKraftBoats.com)  
Premier — [Pontoons.com](http://Pontoons.com)  
Rinker — [RinkerBoats.com](http://RinkerBoats.com)

Silver Wave — [SilverWaveBoats.com](http://SilverWaveBoats.com)  
SouthWind — [SouthWindBoats.com](http://SouthWindBoats.com)  
Starcraft — [StarcraftMarine.com](http://StarcraftMarine.com)  
SunChaser — [SunChaserBoats.com](http://SunChaserBoats.com)  
Sylvan — [SylvanMarine.com](http://SylvanMarine.com)  
Tahoe — [TahoePontoons.com](http://TahoePontoons.com)  
Weeres — [Weeres.com](http://Weeres.com)

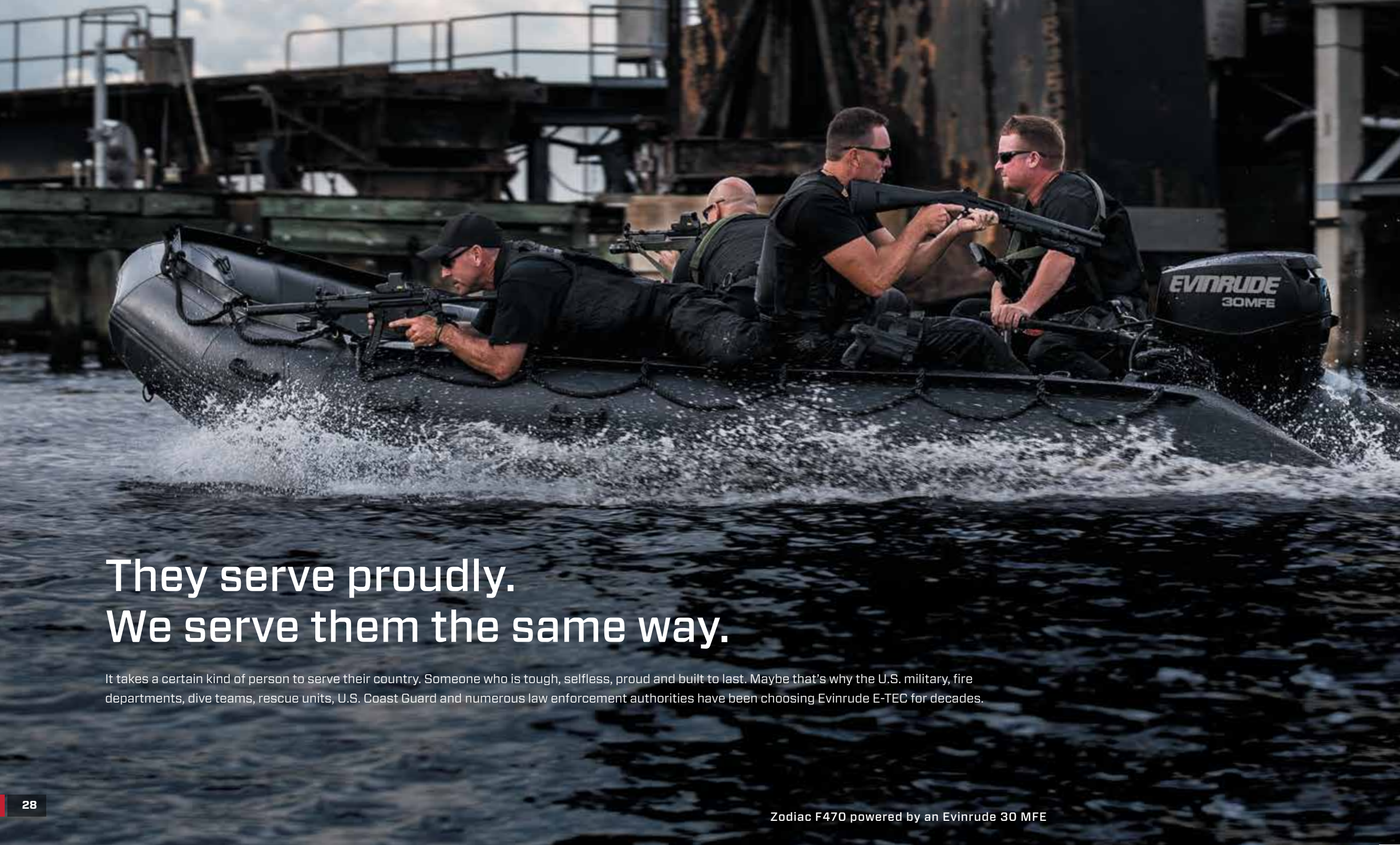

They serve proudly.  
We serve them the same way.

It takes a certain kind of person to serve their country. Someone who is tough, selfless, proud and built to last. Maybe that's why the U.S. military, fire departments, dive teams, rescue units, U.S. Coast Guard and numerous law enforcement authorities have been choosing Evinrude E-TEC for decades.

Zodiac F470 powered by an Evinrude 30 MFE

## GOVERNMENT

We're proud that the United States armed forces rely on the fully submersible Evinrude Multi-Fuel Engine (MFE). It keeps them mobile and concealed at the same time. The men and women who require the most reliable boating experience possible to serve their country use Evinrude, the outboard engine that can deliver the same experience for you.

### EVINRUDE 55 MFE AND 30 MFE

- Built tough for military and government applications
- First outboard capable of running on multiple fuel types
- Optional pump jet propulsion for thrust without prop



## PREFERRED GOVERNMENT PARTNERS

Armstrong Marine - [ArmstrongMarine.com](http://ArmstrongMarine.com)  
 Brunswick Commercial - [BrunswickCGP.com](http://BrunswickCGP.com)  
 Metal Shark Boats - [MetalSharkBoats.com](http://MetalSharkBoats.com)  
 MetalCraft Marine - [MetalCraftMarine.com](http://MetalCraftMarine.com)  
 Moose Boats - [MooseBoats.com](http://MooseBoats.com)  
 North River Boats - [NorthRiverBoats.com](http://NorthRiverBoats.com)  
 Ocean Craft Marine - [OceanCraftMarine.com](http://OceanCraftMarine.com)

Oquawka Boats & Fabrications - [OquawkaBoats.com](http://OquawkaBoats.com)  
 Rescue One Connector Boats - [RescueONE.com](http://RescueONE.com)  
 Ribcraft - [RibcraftUSA.com](http://RibcraftUSA.com)  
 SAFE Boats - [SAFEBoats.com](http://SAFEBoats.com)  
 Silver Ships - [SilverShips.com](http://SilverShips.com)  
 Willard Marine - [WillardMarine.com](http://WillardMarine.com)

William Munson - [MunsonBoats.com](http://MunsonBoats.com)  
 WING Inflatables - [Wing.com](http://Wing.com)  
 WorkSkiff - [WorkSkiff.com](http://WorkSkiff.com)  
 Zodiac Hurricane - [ZodiacMilPro.com](http://ZodiacMilPro.com)  
 Zodiac Marine - [ZodiacMarineUSA.com](http://ZodiacMarineUSA.com)



# Evinrude Engine Specifications.



Blue Wave 2400 Pure Bay powered by an Evinrude E-TEC G2 300 HP

## Evinrude E-TEC G2



HIGH OUTPUT (H.O.)



V6

Horse Power	250 H.O.   225 H.O.   200 H.O.	300HP   250HP   225HP
Engine Type	V6 74° E-TEC D.I.	V6 74° E-TEC D.I.
Bore x Stroke - in (mm)	3.854 x 3.000 (98 x 76)	3.854 x 3.000 (98 x 76)
Displacement - cu in (cc) L	210 (3441) 3.4 L	210 (3441) 3.4 L
Gear Ratio (shaft length) <sup>1</sup>	1.85:1	1.85:1
Full Throttle RPM Range	5400-6000 RPM	5400-6000 RPM
Weight - lbs (kg) <sup>2</sup>	537 (244)	558 (253)
Starting <sup>1</sup>	Electric	Electric
Fuel Induction	E-TEC Direct Injection with stratified low RPM combustion mode	E-TEC Direct Injection with stratified low RPM combustion mode
Alternator Output	133 Amps Total   50 net Dedicated   14 amps @ idle	133 Amps Total   50 net Dedicated   14 amps @ idle
Steering	Remote - Dynamic Power Steering*   Integrated Hydraulic Steering	Remote - Dynamic Power Steering   Integrated Hydraulic Steering
Trim Method	Trim & Tilt	Trim & Tilt
Trim Range	-6° to 15°	-6° to 15°
Tilt Range	81°	81°
Shaft Length - in (mm)	20" (508)   25" (635)	20" (508)   25" (635)   30" (762)
Lubrication	Multi-point Targeted Oiling	Multi-point Targeted Oiling
Oil Tank Capacity - gal (L)	On-Engine 2 (7.5)   Optional Accessory 3, 1.8 (11.4, 6.8)	On-Engine 2 (7.5)   Optional Accessory 3, 1.8 (11.4, 6.8)
Recommended Oil	Evinrude   Johnson XD-100 Oil	Evinrude   Johnson XD-100 Oil
Recommended Fuel	87 Octane	87 Octane
Mounting Centers	Minimum 26"	Minimum 26"
Steering Angle	+/- 32° from center, both directions	+/- 32° from center, both directions
Integrated Features <sup>1</sup>	Dual Axis Rigging   i-Trim	Dual Axis Rigging   i-Trim

\*On equipped models



Manitou 25 SES SHP powered by an Evinrude E-TEC 250 H.O.



HIGH OUTPUT (H.O.)

V6

	250 H.O.	225 H.O., 200 H.O.	150 H.O.	135 H.O.	90 H.O.	15 H.O. <sup>4</sup>	300	250, 225	200, 175, 150
<b>Horsepower</b>	250 H.O.	225 H.O., 200 H.O.	150 H.O.	135 H.O.	90 H.O.	15 H.O. <sup>4</sup>	300	250, 225	200, 175, 150
<b>Engine Type</b>	V6 90° E-TEC D.I.	V6 90° E-TEC D.I.	V6 60° E-TEC D.I.	V6 60° E-TEC D.I.	V4 60° E-TEC D.I.	Inline 2-Cylinder E-TEC D.I.	V6 90° E-TEC D.I.	V6 90° E-TEC D.I.	V6 60° E-TEC D.I.
<b>Bore x Stroke - in (mm)</b>	3.854 x 3.000 (98 x 76)	3.854 x 2.858 (98 x 73)	3.601 x 2.588 (91 x 66)	3.601 x 2.588 (91 x 66)	3.601 x 2.588 (91 x 66)	2.992 x 2.5 (76 x 64)	3.854 x 3.000 (98 x 76)	3.854 x 2.858 (98 x 73)	3.601 x 2.588 (91 x 66)
<b>Displacement - cu in (cc) L</b>	210 (3441) 3.4L	200.1 (3279) 3.3L	158.2 (2589) 2.6L	158.2 (2592) 2.6L	105.4 (1726) 1.7L	35.2 (577) Inline <sup>2</sup>	210 (3441) 3.4 L	200.1 (3279) 3.3L	158.2 (2589) 2.6L
<b>Gear Ratio (shaft length)<sup>1</sup></b>	1.85:1	1.85:1	1.86:1	1.86:1 (20") 1.85:1 (25")	2.00:1 (20") 2.25:1 (25")	2.15:1	1.85:1	1.85:1	1.86:1 (20") 1.85:1 (25")
<b>Full Throttle RPM Range</b>	5300-6000 RPM	5250-6000 RPM	4850-5850 RPM	5300-6000 RPM	5500-6000 RPM	5000-5500 RPM	5300-6000 RPM	5250-6000 RPM	5300-6000 RPM
<b>Weight - lbs (kg)<sup>2</sup></b>	507 (230)	503 (228)	418 (190)	418 (190)	390 (177)	181 (82)	522 (237)	524 (238)	418 (190)
<b>Starting<sup>1</sup></b>	Electric	Electric	Electric	Electric	Electric	Electric and Rope <sup>3</sup>	Electric	Electric	Electric
<b>Controls</b>	Mechanical / ICON EST Digital (Acc'y)	Mech. / ICON EST Digital (Acc'y) Mech. or ICON EST Digital (200 H.O. 25")	Mechanical / ICON EST Digital (Acc'y)	Mech. / ICON EST Digital (Acc'y) Mech. or ICON EST Digital	Mechanical	Mechanical	Mech. / ICON EST Digital (Acc'y) Mech. or ICON EST Digital	Mech. / ICON EST Digital (Acc'y) Mech. or ICON EST Digital	Mech. / ICON EST Digital (Acc'y) Mech. or ICON EST Digital (150 / 200)
<b>Fuel Induction</b>	E-TEC Direct Injection with stratified low RPM combustion mode	E-TEC Direct Injection with stratified low RPM combustion mode	E-TEC Direct Injection with stratified low RPM combustion mode	E-TEC Direct Injection with stratified low RPM combustion mode	E-TEC Direct Injection with stratified low RPM combustion mode	E-TEC Direct Injection with stratified low RPM combustion mode	E-TEC Direct Injection with stratified low RPM combustion mode	E-TEC Direct Injection with stratified low RPM combustion mode	E-TEC Direct Injection with stratified low RPM combustion mode
<b>Alternator Output<sup>3</sup></b>	133 Amps Total / 50 Net Dedicated <sup>5</sup>	133 Amps Total / 50 Net Dedicated <sup>5</sup>	133 Amps Total / 50 Net Dedicated <sup>5</sup>	133 Amps Total / 50 Net Dedicated <sup>5</sup>	133 Amps Total / 50 Net Dedicated <sup>5</sup>	56 Amps Total / 15 Net Dedicated <sup>7</sup>	133 Amps Total / 50 Net Dedicated <sup>5</sup>	133 Amps Total / 50 Net Dedicated <sup>5</sup>	133 Amps Total / 50 Net Dedicated <sup>5</sup>
<b>Steering<sup>1</sup></b>	Remote	Remote	Remote	Remote	Remote (Tiller Accessory)	Remote or Tiller	Remote	Remote	Remote
<b>Trim Method<sup>1</sup></b>	FasTrak™ Power Trim and Tilt	FasTrak™ Power Trim and Tilt	FasTrak™ Power Trim and Tilt	FasTrak™ Power Trim and Tilt	FasTrak™ Power Trim and Tilt (25"), Trac-1 power trim and Tilt (20")	High Speed Power Tilt	FasTrak™ Power Trim and Tilt	FasTrak™ Power Trim and Tilt	FasTrak™ Power Trim and Tilt
<b>Shaft Length - in (mm) Color (hp)<sup>1</sup></b>	20" (508) White   Graphite 25" (635) Graphite	20" (508) White   Graphite 25" (635) White   Graphite	20" (508) White   Graphite 25" (635) Graphite	20" (508) Graphite   White 25" (635) Graphite   White	20" (508) Graphite   White 25" (635) Graphite   White	20" (508) White 15" (391) White   Graphite	20" (508) White 25" (635) White   Graphite 30" (762) White	25" (635) White 30" (762) White	20" (508) Graphite   White 25" (635) Graphite   White



	V4	INLINE 3 CYLINDER	INLINE 2 CYLINDER		MULTI-FUEL <sup>9</sup>	PONTOON		PORTABLES	
<b>Horsepower</b>	115	90, 75	60, 50, 40	30, 25	55, 30	150	115	90, 65	15, 9.8, 6, 4, 3.5
<b>Engine Type</b>	V4 60° E-TEC D.I.	Inline 3-Cylinder E-TEC D.I.	Inline 2-Cylinder E-TEC D.I.	Inline 2-Cylinder E-TEC D.I.	Inline 2-Cylinder E-TEC D.I.	V6 60° E-TEC D.I.	V4 60° E-TEC D.I.	Inline 3-Cylinder E-TEC D.I.	2-cylinder, 1-cylinder
<b>Bore x Stroke - in (mm)</b>	3.601 x 2.588 (91 x 66)	3.601 x 2.588 (91 x 66)	3.601 x 2.588 (91 x 66)	2.992 x 2.5 (76 x 64)	3.601 x 2.588 (91 x 66)	3.601 x 2.588 (91 x 66)	3.601 x 2.588 (91 x 66)	3.601 x 2.588 (91 x 66)	61 x 60 (2.4 x 2.36), 55 x 44 (2.17 x 1.73)   59 x 45 (2.32 x 1.77), 55 x 36 (2.17 x 1.42)
<b>Displacement - cu in (cc) L</b>	105.4 (1726) 1.7L	79.1 (1295) Inline <sup>3</sup>	52.7 (863) Inline <sup>2</sup>	35.2 (577) Inline <sup>2</sup>	52.7 (863) Inline <sup>2</sup>	158.2 (2592) 2.6L	105.4 (1726) 1.7L	79.1 (1295) Inline <sup>3</sup>	351 (21.41), 209 (12.8) 123 (7.5), 85.5 (5.2)
<b>Gear Ratio (shaft length)<sup>1</sup></b>	2.00:1 2.25:1	2.00:1(20") 2.25:1(25")	2.90:1	2.15:1	2.67:1	1.86:1 (20")	2.44:1 (20")	2.36:1	2.15:1 2.08:1
<b>Full Throttle RPM Range</b>	5500-6000 RPM	5000-5500 RPM	5500-6000 RPM	5500-6000 RPM	5500-6000 RPM	5300-6000 RPM	5500-6000 RPM	5000-5500 RPM	4500-6000 RPM
<b>Weight - lbs (kg)<sup>2</sup></b>	390 (177)	320 (145)	232 (105) (40 HP) 240 (109) (50 HP, 60 HP)	150 (68)	154 (70) (30MFE) 250 (113) (55MFE)	418 (190)	390 (177)	320 (145)	114.4 (52), 81.5 (37), 55 (25), 57 (26), 41 (18.4)
<b>Starting<sup>1</sup></b>	Electric	Electric	Electric or Rope (40 only)	Electric or Rope <sup>8</sup>	Rope <sup>3</sup>	Electric	Electric	Electric	Electric or Manual
<b>Controls</b>	Mechanical	Mechanical	Mechanical	Mechanical	Mechanical	Mech. / ICON EST Digital (Acc'y) Mech. or ICON EST Digital	Mech. / ICON EST Digital (Acc'y) Mech. or ICON EST Digital	Mechanical	Remote Control or Tiller Handle
<b>Fuel Induction</b>	E-TEC Direct Injection with stratified low RPM combustion mode	E-TEC Direct Injection with stratified low RPM combustion mode	E-TEC Direct Injection with stratified low RPM combustion mode	E-TEC Direct Injection with stratified low RPM combustion mode	E-TEC Direct Injection with stratified low RPM combustion mode	E-TEC Direct Injection with stratified low RPM combustion mode	E-TEC Direct Injection with stratified low RPM combustion mode	E-TEC Direct Injection with stratified low RPM combustion mode	Carbureted
<b>Alternator Output<sup>3</sup></b>	133 Amps Total / 50 Net Dedicated <sup>5</sup>	81 Amps Total / 25 Net Dedicated <sup>6</sup>	81 Amps Total / 25 Net Dedicated <sup>6</sup>	56 Amps Total / 15 Amps Net Dedicated <sup>7</sup>	81 Amps Total / 25 Net Dedicated <sup>6</sup>	133 Amps Total / 50 Net Dedicated <sup>5</sup>	133 Amps Total / 50 Net Dedicated <sup>5</sup>	81 Amps Total / 25 Net Dedicated <sup>6</sup>	Only on Electric models: 12V, 60W, 5A 12V, 80W, 6A 12V, 145W, 12A
<b>Steering<sup>1</sup></b>	Remote (Tiller Accessory)	Remote (Tiller Accessory)	Remote or Tiller (Tiller Accessory)	Remote or Tiller	Tiller	Remote (Tiller Accessory)	Remote (Tiller Accessory)	Remote (Tiller Accessory)	Tiller or Remote
<b>Trim Method<sup>1</sup></b>	FasTrak™ Power Trim and Tilt	FasTrak™ Power Trim and Tilt	Power Trim and Tilt or Manual Tilt (40 only)	Power Trim and Tilt or Manual Tilt	Manual Tilt w/ assist cylinder	Power Trim and Tilt or Manual Tilt	Power Trim and Tilt or Manual Tilt	Power Trim and Tilt or Manual Tilt	Manual or Power Tilt
<b>Shaft Length - in (mm) Color (hp)<sup>1</sup></b>	20" (508) Graphite   White 25" (635) Graphite   White	20" (508) Graphite   White 25" (635) White (90 only)	20" (508) Graphite   White	15" (381) Graphite   White 20" (508) Graphite   White	20" (508) Tactical Black	20" (508) Graphite   White	20" (508) Graphite   White	20" (508) Graphite   White 25" (635) White	15" (381) Blue 20" (508) Blue 25" (635) Blue



Ranger Z117 powered by an Evinrude E-TEC 115 HP

<sup>1</sup> May vary based on engine model number.

<sup>2</sup> Weight refers to the actual weight (including all fluids) for the lightest model/version of each horsepower listed in that grouping.

<sup>3</sup> Rope-start-only models require optional charging accessory kit.

<sup>4</sup> Models include propeller and fuel tank.

<sup>5</sup> Variable Voltage Computer Controlled 133 Amp. Current amp calculated at 13.5 V. Net dedicated battery charging power output is 50 Amp.

<sup>6</sup> Variable Voltage Computer Controlled 81 Amp. Current amp calculated at 13.5 V. Net dedicated battery charging power output is 25 Amp.

<sup>7</sup> 56 Amp. Current amp calculated at 13.5 V. Net dedicated battery charging power output is 15 Amp.

<sup>8</sup> Electric also has rope capabilities.  
<sup>9</sup> Available for Government Purchase Only.

Note: Counter Rotation Gearcase with Power Trim & Tilt available on 300-, 250-, 225-, 200-, 175-, 150-, 130- and 115-hp engines (excludes High Output models).

Fuel economy: Fuel economy claims are based on laboratory tests utilizing ISO 8178-4 and boat tests performed at BRP facilities. Actual fuel usage will vary depending on the boat, payload, operating conditions, propeller, and driving habits. \*\*\*Power Ratings: Evinrude® outboards are power rated in accordance with National Marine Manufacturer's Association (NMMA) procedure using the International Council of Marine Industry Associates (ICOMIA) standard 28/83. Remote Control: Not supplied with engine. For all models, a wide variety of props are available at extra cost. A full line of Cyclone™, Hydrus®, SSP®, Raker® II Rogue™, Viper™ and Rebel® propellers are available for standard and counter-rotation models. Maximum Boat Horsepower: By law, most outboard boats up to 20 feet in length must carry a plate certifying the maximum horsepower permitted under U.S. Coast Guard regulations. Do not exceed boat's horsepower rating or tamper with engine's emission levels or components. Warranty: The Evinrude Limited Warranty has been furnished to Evinrude dealers for inspection at the point of sale and is included

with the Operator's Guide furnished with each motor. Three year Evinrude warranties apply to new 2004, 2005, 2006, 2007, 2008, 2009, 2010, 2011, 2012, 2013, 2014 and 2015 engines sold by authorized dealers in North America for recreational use only. Contact the company for information on government, commercial, and promotional engine warranties. See limited warranty statement for full details. Five year Evinrude warranties apply to new 2015 Evinrude E-TEC G2 engines sold by authorized dealers in North America for recreational use only and are a three year Evinrude Limited Warranty, plus two years of BRP Extended Service Terms. Five year corrosion warranties apply to new 2015 Evinrude E-TEC G2 engines sold by authorized dealers in North America for recreational use only. Specifications: In furtherance of our policy of continual product improvement, we reserve the right to discontinue, substitute, change, or improve the design of any outboard motor at any time, without assuming obligation to modify motors previously manufactured. We reserve the right, at

any time, to discontinue or change specifications, price, designs, features, models, or equipment without incurring obligation. The information in this brochure is based on the latest specifications available at the time of printing. See your Evinrude dealer for the latest product information. Some models depicted herein may contain accessories or be shown with options which are available at an extra cost from your Evinrude dealer. Engine performance may vary depending on, among other things, general conditions, ambient temperature, ability, options, modifications, and driver and passenger payload weight, engine type, and optional equipment. Information contained in this publication reflects domestic U.S. and Canadian product availability. Product availability and warranty may vary outside the U.S. and Canada. For advertising purposes, some pictures in this brochure include professional drivers executing maneuvers under ideal and/or controlled conditions. Do not attempt any of these, or any other risky maneuvers, if they're beyond your level of driving ability. Always consult your local dealer when selecting an outboard for

your particular needs and carefully heed and pay special attention to your Operator's Guide, and the on-product labeling. Always drive responsibly and safely. Severe injury can result from ignoring warnings, not following the instructions, or improper use of boats and engines. Use common sense and courtesy. Always observe applicable local laws and regulations. Respect the rights of, and keep a safe distance from, other recreationists, bystanders, and the shoreline. Always wear the appropriate clothing, including a Coast Guard-approved P.F.D. as dictated by the circumstances including, but not limited to, the weather, boating conditions, and age and abilities of the occupants. Don't drink and drive. BRP US Inc. 10101 Science Drive, Sturtevant, Wisconsin 53177. ©2014 Bombardier Recreational Products Inc. (BRP) All rights reserved. ®, TM and the BRP logo are trademarks of BRP or its affiliates. ‡ All other trademarks are the property of their respective owners.



# THE WORLD IS OUR PLAYGROUND

Nothing is more valuable than your playtime. That is why BRP is dedicated to continually finding new and better ways to help you enjoy your favorite powersports. From snow to water to both on- and off-road fun, our passion for adventure fuels the innovations that result in the ultimate powersports experience for our customers. We value



the land and water we play on and are committed to protecting it. Our desire to thrill is paired with an emphasis on rider responsibility, placing personal safety above all else. So that each outing can be the most enjoyable, memorable and thrilling experience possible. Because your free time should always be your best time.

[www.brp.com](http://www.brp.com)



SKI-DOO® LYNX® SEA-DOO® EVINRUDE® ROTAX® CAN-AM®